

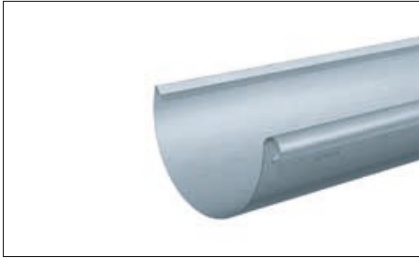

ROOF DRAINAGE SYSTEM

Gutters, Downpipes and Accessories



Gutter
half-round/box section,
with notched bead

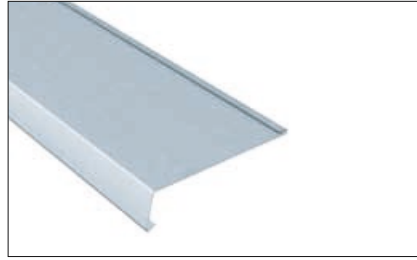

Eaves Profile
with/without seam,
with/without bead

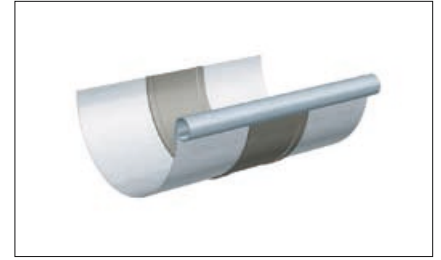

Expansion Joint
short, half-round/box section,
expansion element zinc-grey



Stopends
half-round/box section

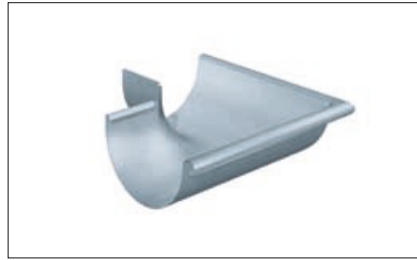

Halfround Corner
external/internal, 90°,
deep-drawn from one piece

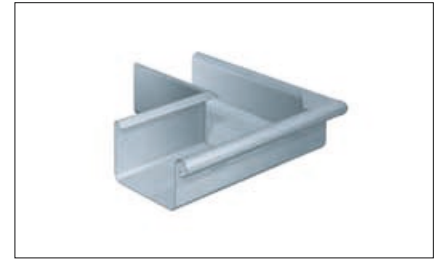

Box Corner
external/internal, 90°,
length 300 mm, soldered

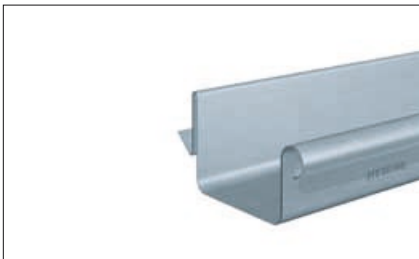

Balcony Gutter
with notched bead



Downpipe
round or box-shaped, high-frequency
welded, Europ. patent 0284141



Standpipe
DN 110 and 125, welded

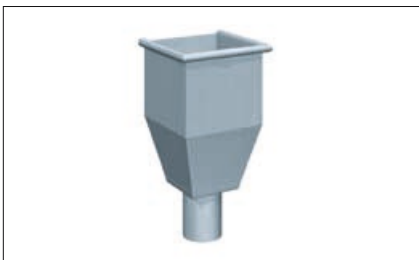

Hopper Head
box-shaped, round outlet



Elbow
40° / 60° / 72° / 85°

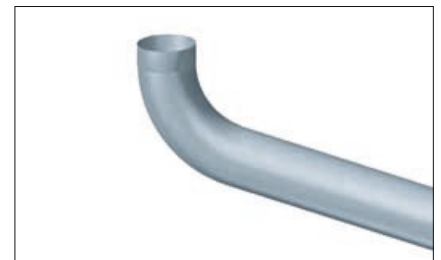

Extended Pipe Bend
60° / 72°



**Universal Downpipe Bracket
with Lightning Protection Attachment**



Water Diverter / Leaf Collector
with removable leaf screen



Rain Collector
including the GARDENA® 1/2" hose con-
nector with shut-off valve and a 1" con-
necting hose

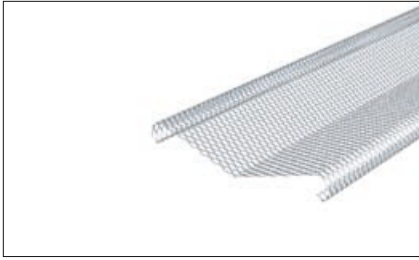

Leaf Guard
for half-round gutter



Snap-Lock Bracket System
Bracket mounting rail with plug connection and Snap-lock bracket complying with DIN EN 1462



Plug-in Gutter Outlet
half-round or box-shaped, machine-welded



Pipe Branch 60° and Pipe Reducer
for pipe junctions



Cover Sleeve
revision opening with standpipe collar



The Trademark for Quality in Roof Drainage

A wide range of forms and individual applications. Half-round or box-shaped, customised designs and accessories: Boasting over 500 items, the RHEINZINK roof drainage system is the most comprehensive on the market. And available in three different finishes as well: RHEINZINK-prePATINA bright rolled develops its classical blue-grey patina during the natural weathering process. The preweathered versions RHEINZINK-prePATINA blue-grey and prePATINA graphite-grey already leave the works with a permanent finish that has all the elegance of a zinc patina that otherwise forms over time. All three impress with their aesthetic lines, varied designs, outstanding accuracy of fit and long, maintenance-free life.

All products are made of the natural material RHEINZINK. They satisfy even the most stringent quality criteria and also offer an exemplary life cycle assessment: RHEINZINK can be recycled 100%. Following comprehensive evaluation of its entire life cycle it was declared as an environmentally friendly building product according to DIN ISO 14025, Type III, some years ago.



Quality Characteristics

A decision in favour of RHEINZINK is always a decision in favour of quality. As an unmistakable sign of its origin, each RHEINZINK component comes with very specific identification, which is stamped onto the product. The mark endorses the RHEINZINK quality for generations to come.

Lasting Values

The 30-year guarantee underlines the proverbial longevity of this sustainable material – so offering customers additional reliability.

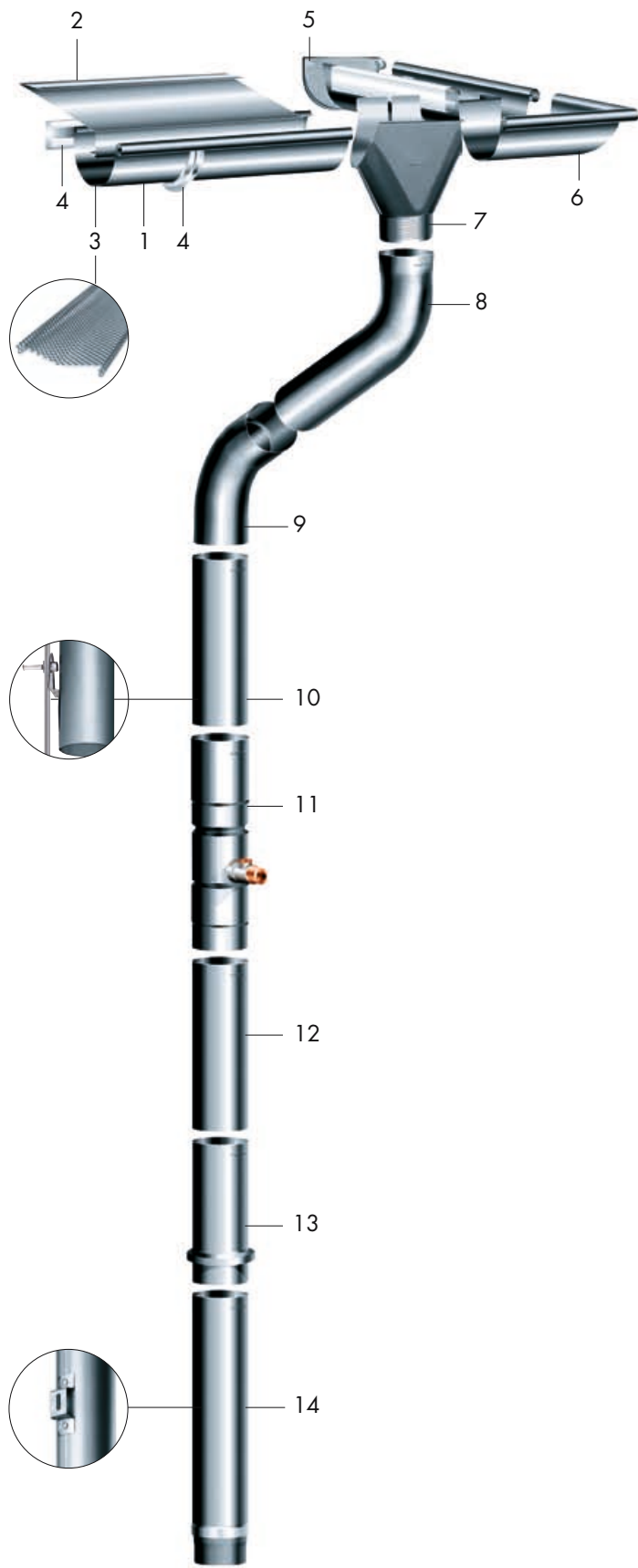

Key:

- 1 Halfround gutter
- 2 Eaves profile
- 3 Leaf guard
- 4 Gutter brackets/Snap-lock system
- 5 Stopend
- 6 Gutter corner
- 7 Plug-in gutter outlet
- 8 Extended pipe bend
- 9 Pipe bend
- 10 Universal downpipe bracket with lightning protection attachment
- 11 Rain collector
- 12 Patented high frequency-welded downpipe
- 13 Cover sleeve
- 14 Standpipe